

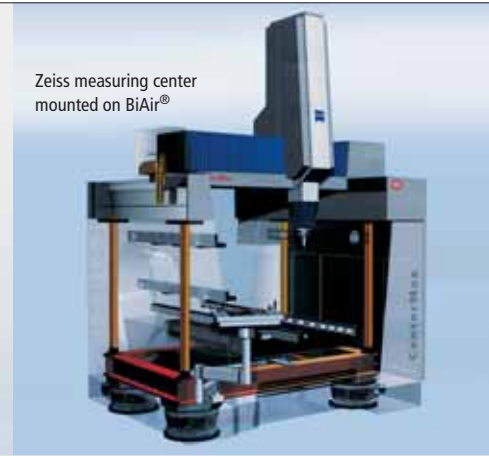

BiAir®



Zeiss measuring center mounted on BiAir®

## BiAir®

### Product Description

The Air-Spring Insulator BiAir® consists of a cast aluminum body whose air volume is enclosed by a thin-walled, flexible and pressure-resistant rolling diaphragm. The piston is seated on this diaphragm and is pushed into the air volume.

This design causes highly effective vibration insulation.

In order to obtain as high a dampening effect as possible, the air space is split into two chambers (load/dampening volume) linked by air pipe. By the adjustable valve the dampening can be easily changed from outside. Due to the friction caused by the air-stream passing through the bypass valve, up to 20% dampening can be effected. Additional safety valves will protect the roller diaphragm from getting damaged by over-inflation.

### Range of Application

Highly effective vibration insulation of sensitive measuring and testing machines, fine-machining plant, as well as optical and electronic equipment. Another important range of application is the vibration-insulated foundation of vehicle, motor and other performance testers. BiAir® Air-Spring insulators are extremely well suited for the insulation of foundations e.g. equivalent machine loads.

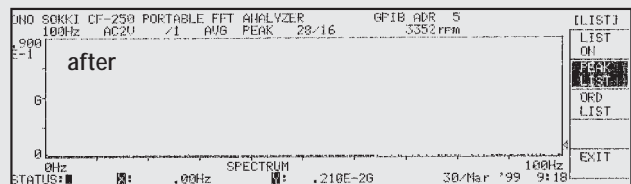
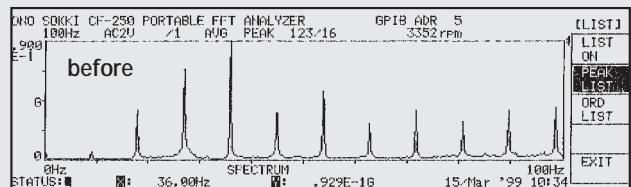

### Advantages compared with conventional steel springs

BiAir® Air-Spring insulators with level control are an active system. The machine/foundation level consistency will always be preserved! Automatic leveling/adjustment!

## BILZ level controller systems

Level control is an important part of an optimally functioning air spring system. The automatic level controller can be utilized to overcome the problem associated with load changes in air-spring insulated machines, which can result in tilting of the machine.

The height of the specific elements BiAir® or FAEBI® can be controlled by changing the air pressure in the air-spring insulators. Quick inflation or deflation will hold the machines level even if their center of gravity keeps changing.

### Control circuit

The circuit consists of at least three air springs. If more air springs are needed for structural or loading reasons, the system must always include 3 position pickups, e.g. three controlled components in order to avoid statical overdefinition. This is achieved by connecting sets of air springs in parallel.

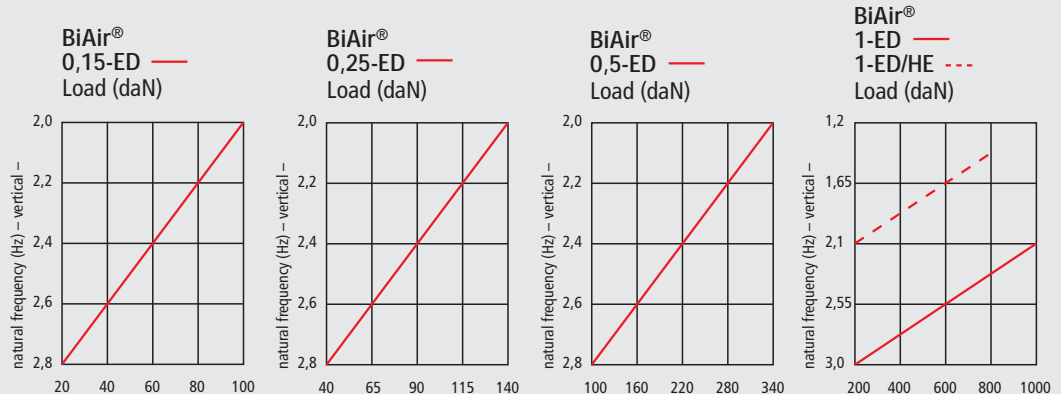

# Membrane Air-Spring Insulator BiAir®

with deep natural frequency and adjustable dampening (pat.)  
for vibration insulation of measuring and testing machines,  
optical and electronic equipment, laser machines,  
fine machining plant, vehicle and motor performance testers etc.

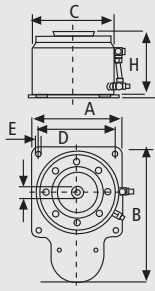

type

BiAir 0,15-ED\*  
BiAir 0,25-ED\*  
BiAir 0,5-ED\*  
BiAir 1-ED\*  
BiAir 2-ED\*  
BiAir 2,5-ED\*

Ø A mm

76  
110  
130  
200  
260  
300

width W mm

72  
182  
190  
275  
350  
390

Ø C mm

72  
110  
129  
200  
260  
300

workheight H mm

77  
87  
100  
100  
100  
100

max. load daN at max. 4 bar

67  
113  
267  
633  
1420  
1967

max. load daN at max. 6 bar

100  
170  
400  
950  
2130  
2950

natural frequency Hz (vertical) approx.

2,5  
2,5  
2,5  
2,5  
2,5  
2,5

natural frequency Hz (horizontale) approx.

2,5  
2,5  
2,5  
2,5  
2,5  
2,5

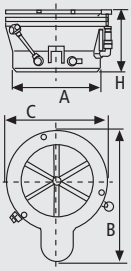

BiAir 0,5-ED\*\*  
BiAir 1-ED\*\*  
BiAir 2-ED\*\*  
BiAir 2,5-ED\*\*  
BiAir 3-ED\*\*  
BiAir 4-ED\*\*  
BiAir 5-ED\*\*

120  
172  
226  
271  
348  
490  
747

216  
288  
335  
378  
467  
605  
855

129  
200  
260  
300  
382  
530  
798

157  
157  
157  
157  
157  
157  
157

267  
633  
1420  
1967  
3413  
6573  
15573

400  
950  
2130  
2950  
5120  
9860  
23360

natural frequency Hz (vertical) approx.

2,5  
2,5  
2,5  
2,5  
2,5  
2,5  
2,5

natural frequency Hz (horizontale) approx.

2,5  
2,5  
2,5  
2,5  
2,5  
2,5  
2,5

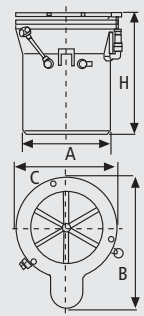

BiAir 1-ED/HE\*\*  
BiAir 2-ED/HE\*\*  
BiAir 2,5-ED/HE\*\*  
BiAir 3-ED/HE\*\*  
BiAir 4-ED/HE\*\*

172  
226  
271  
348  
490

288  
335  
378  
467  
605

200  
260  
300  
382  
530

307  
307  
307  
307  
307

633  
1420  
1967  
3413  
6573

950  
2130  
2950  
5120  
9860

natural frequency Hz (vertical) approx.

1,5  
1,5  
1,5  
1,5  
1,5

natural frequency Hz (horizontale) approx.

2,5  
2,5  
2,5  
2,5  
2,5

\*Steel \*\*Aluminium

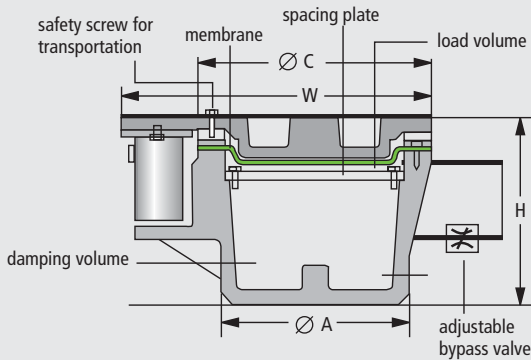

When choosing the size of the air-spring consider loading at 4 bar only.

Air springs with higher max. loads as well as air springs with lower natural frequencies can be supplied upon request!

BiAir®  
2-ED ———  
2-ED/HE - - -  
Load (daN)

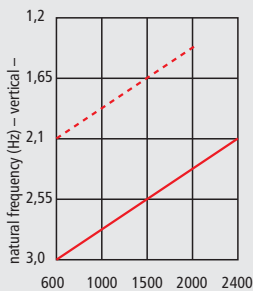

BiAir®  
2,5-ED ———  
2,5-ED/HE - - -  
Load (daN)

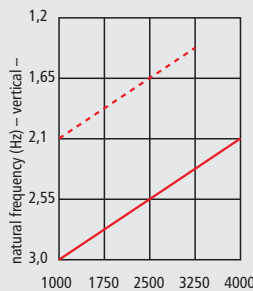

BiAir®  
3-ED ———  
3-ED/HE - - -  
Load (daN)

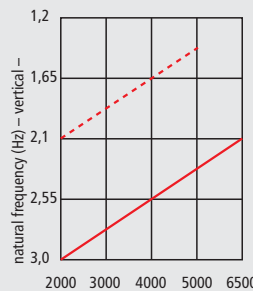

BiAir®  
4-ED ———  
4-ED/HE - - -  
Load (daN)

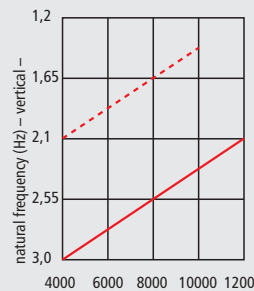

BiAir®  
5-ED ———  
Load (daN)

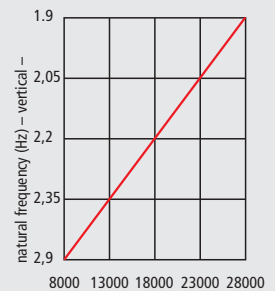



BiAir® MPN

## BiAir® mechanical-pneumatic positioner/controller

The mechanical-pneumatic relief valves are a simple yet effective solution. The level is constantly scanned by a plunger. The plunger position is transmitted to a spool valve. Depending on the spool valve position, pressure is either applied to the air spring or vented from the inside of the air spring. The machine level can be maintained at an accuracy  $\pm 1/100$  mm.

Principally three control valves are used. The incoming air supply is conditioned with a pressure regulator to limit system pressure to a maximum of 6 bar and with a water trap to remove vapor and an air filter to remove dust and any foreign bodies from the air supply.



BiAir® EPN

## BiAir® electro-pneumatic positioner/controller

### Advantages

Important advantages of the BILZ level control are:

- a high reset accuracy e.g. level accuracy of  $\pm 1/100$  mm
- extremely short reaction time (within the milli-second range)
- the general possibility of being able to optimally adapt (increase and reset) the speed of the system to the specific conditions (control circuit)
- wear-resistant and sturdy relief valves
- simple and effective set-up operation

### System components

Each system consists of 3 position sensors, 3 electro-pneumatic relief valves, one control unit (digital computer logic), the air-supply regulator and filter units.

Even the most severe conditions are mastered by the electro-pneumatic positioner. It is used mainly where high reset precision and extremely short reaction times are required.

Any deviation (difference between desired value and actual value) from the desired height (desired value) of the air spring insulators is measured at a precision of up to  $1/100$  mm accuracy by means of position sensors.

In the control unit, these electronic signals will then be processed and the air spring elements will be inflated or deflated accordingly for level equalisation via the pneumatic relief valves.

### Control unit

The control unit consists of a printed circuit board, containing the entire logic of the 3 control circuits, 3 air pressure displays for the air springs, adjusting screws for the adjustment of the machine, selection of the controller speed, and a switch to enable complete deflation of the air springs. The control unit can be supplied either as a 19 inch rack mount unit or completely enclosed within a cabinet.

### Software

As an optional feature, a special software package is available. By means of this software, the adjustment and optimization of controlled conditions, the registration of adjustment parameters as well as error determination can be carried out via the serial interface (serial interface provided on the control unit).

Furthermore, the integrated serial interface enables link-ups with available machine computers or systems to be insulated. A number of more complex system modes can be realized this way.